

# ASSEMBLY AND INSTALLATION INSTRUCTIONS

T0627

**WARNING:** TO AVOID RISK OF ELECTRICAL SHOCK, BE SURE TO SHUT OFF POWER BEFORE INSTALLING OR SERVICING THIS FIXTURE.

**NOTES:** 1. Before installing, consult local electrical codes for wiring and grounding requirements.  
2. READ AND SAVE THESE INSTRUCTIONS.

## Hardware Package (included):

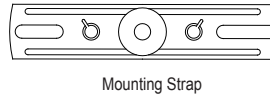
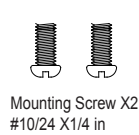
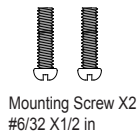
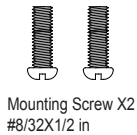

## Tools Needed:

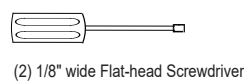
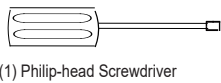

1. Phillips-head screwdriver for attaching mounting screws to mounting strap, mounting bracket and fixture to mounting bracket.
2. 1/8" wide flat-head screwdriver for connecting the source wires into the wiring terminal station on the mounting bracket.

## Important to Know:

1. If you are not familiar with state and local electrical codes, it is recommended that you consult with a qualified electrician.
2. This fixture requires a 120 VAC, 60 Hz power source.
3. For general safety and to avoid any possible damage to the sensor, be sure the power is switched "off" before adjustment.

**Maximum Wattage: 22 W**

**Working Temperature Range: -13°F ~ 113°F**

**Note: Fixture can be wall mounted or eave mounted.**

## Features:

1. Energy saving LED fixture.
2. Capable to function as a standalone wall switch light or as part of a Link Group.
3. When connected to a Link Group, light will receive signal to turn ON at full brightness automatically when motion sensor signal is detected and then DIMS light to low level brightness automatically when motion stops.
4. When connected to a Link Group, light will receive signal to remain OFF daylight hours and automatically turns the light ON during evening hours.
5. The wall switch that the light is connected to can be used to manually override and change functionality and settings of certain modes.

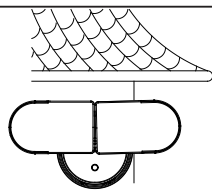

Wall Mounted

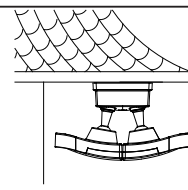

Eave Mounted

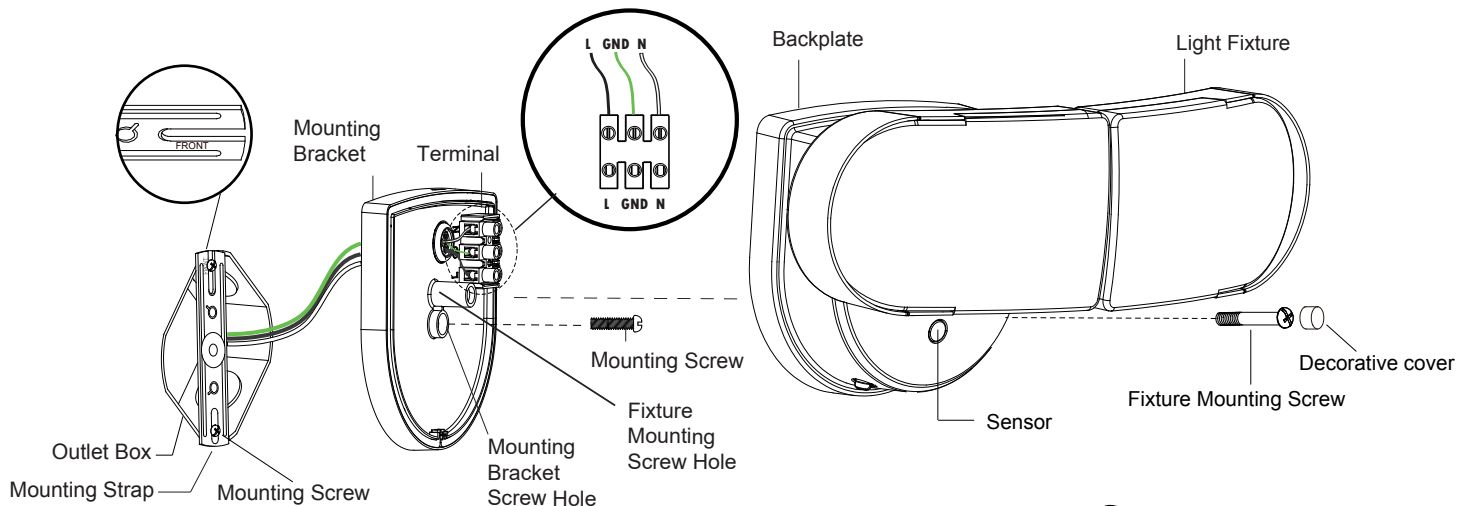

## Installation Steps

Turn off the power at fuse or circuit box.

1. The fixture mounting bracket is pre-assembled on the light fixture. Unscrew both the decorative cover and the fixture mounting screw in order to remove the mounting bracket.
2. Install the mounting strap to the outlet box with the stamped word "FRONT" facing away from the outlet box, using two mounting screws that best fit the outlet box. Mounting bracket should sit flush against wall surface when secured. (Choose one matching pair of suitable mounting screws from the 3 pairs provided).
3. Pull out the source wires from the outlet box. Using a 1/8" flat-head screwdriver connect the black wire from the outlet box to the "L" interface of the terminal station on the mounting bracket. Connect the white wire from the outlet box to the "N" interface of the terminal station on the mounting bracket. Connect the Ground wire from outlet box to "GND" interface of the terminal station on the mounting bracket. Carefully tuck the wires back into the outlet box.
4. Place mounting bracket against the outlet box, insert the mounting bracket screw through the mounting bracket hole, thread mounting bracket screw into the center hole of the mounting strap. Tighten the mounting bracket screw securely.
5. Attach the backplate of the light fixture to the mounting fixture mounting screw. Then push the decorative cover firmly into the fixture mounting screw hole on the light fixture. Tighten the fixture mounting screw securely.
6. With silicone caulking compound, caulk completely around where the back plate meets the wall surface.  
**CAUTION: Be sure to caulk completely where the back plate meets the wall surface to prevent water from seeping into the outlet box.**

Turn on the power at the main fuse or circuit breaker box.

### Adjusting the Light Head:

1. Gently grasp the light heads and tilt them up or down, left or right to adjust the light coverage area. Keep the light heads at least 1" (25mm) away from the sensor. (See Fig. 1)
2. Keep the light heads 30° below horizontal to avoid water damage and electrical shock.

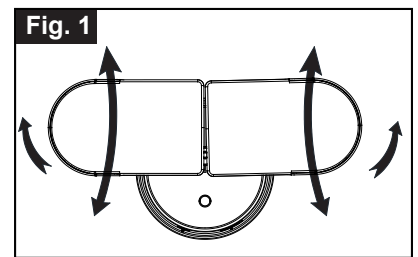

### AcXYg of Switch Control Light:

Choose a mode by rotating the control switches on the bottom of the fixture. (See Fig.2).

**Note: When power is first applied, the light will initially turn on and warm up for 30 seconds**

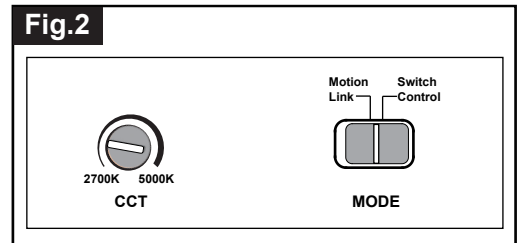

1. Switch Control Mode (No network, No Linkage)
  - In "Switch Control" Mode: when the light switch is turned on, the light turn on at 100% brightness and the pre-selected CCT color (2700K~5000K).
  - In "Switch Control" Mode: to change the brightness level of the light, turn the wall switch "OFF" and then back "ON" twice within 3 seconds. The light will switch from 100% brightness to 30% brightness and pre-selected color (2700K~5000K) or turn the wall switch OFF for 5 seconds, then turn back ON.
2. Motion Link Mode
  - In "Motion Link" Mode, the light will turn on at 30% brightness and 2700K CCT  
When the light receives the motion signal:  
Between Dawn to Dusk (daytime hours): the light will remain off.  
Between Dusk and Early Evening hour setting on Motion Light: the light will turn on to Low Level setting (30% brightness and 2700K CCT).  
Between Early Evening setting setting on Motion Light and Dawn: the light will turn on to High Level setting (100% brightness and 5000K CCT). When motion is no longer detected a signal will be sent to return the light to Low Level settings (30% brightness and 2700K CCT).  
At Dawn: the light will turn off.
3. Unlinking from a Link Group
  - Press and hold the Link button on the body of light for 3 seconds, the light will flash 3 times to exit linkage.
  - In RF Link State, shift the switch from Motion Link Mode to Switch Control Mode, the light will return to Switch Control function.

#### 4. RF Linking Network Setup

- From all the light units you would like to link, select one as the main unit and the others as sub-units.
- First, setup all of the sub-units by pressing the Link button two times within 3 seconds. The sub-units will flash once every 1 second (meaning they are waiting to receive a linking signal from the main light).
- Then press and hold the main unit Link button for 5 seconds. The main unit will flash slowly (once every 3 seconds), and when the sub-units have paired with the signal, the sub-units will stop flashing (confirming they have paired with the main unit). If pairing is unsuccessful, the sub-unit will keep flashing.
- When all the sub-units have stopped flashing, press the Link button on the main unit once to complete the pairing process (the main unit will then stop flashing).
- After completing the pairing process, any light within the Link group range can send or receive the photo sensor or motion sensor signal from the other light and respond accordingly.

**Note: Maximum number of units per link group is 10 units. The maximum linking distance between lights is 120ft.**

#### 5. Unlinking the unit from the Link Group.

- Press and hold the Link button on the sensor head for 3 seconds, the light will flash 3 times to confirm reset and remove from the Link Group.
- All lights will need to be reset before setup the Link Group or when adding new light to the Link Group.

### Manual Override

#### 6. Switch Control Mode

- In "Switch Control" Mode (See Fig.3). Turn the wall switch OFF and back ON twice within 3 seconds, the light will switch from 100% brightness to 30% brightness and pre-selected CCT (2700K~5000K). To shift back to 100% brightness and pre-selected CCT (2700K~5000K), turn the wall switch OFF and back ON twice within 3 seconds again, or power the switch off for 5 seconds and then turn back.

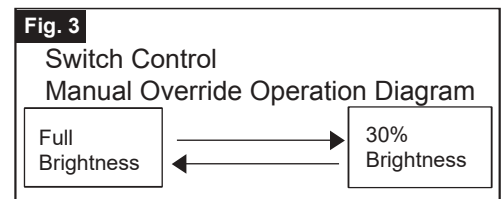

#### 7. Motion Link Mode

- In "Motion Link" Mode linkage state (See Fig.4). Turn the wall switch OFF and back ON twice within 3 seconds, the light will stop to receive motion sensor signal and photo sensor signal from other lights and stay on at 100% brightness and pre-selected CCT color (2700K~5000K).
- To shift back into the linkage state, turn the wall switch OFF and back ON twice within 3 seconds, the light will return to 30% brightness and 2700K CCT color. Note if the light is in Motion Link Mode and has not prior linked to a group, it will remain at 100% brightness and pre-selected CCT (2700K~5000K).

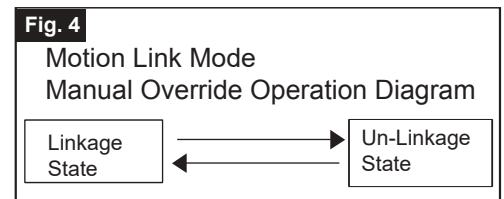

### Troubleshooting

---The light does not come on at all:

1. Make sure the wall switch and circuit breaker are on.
2. Make sure the wiring is correct.
3. Cover the sensor with dark color cloth to verify that the ambient light level is not too high.

---The light comes on for no apparent reason

1. Re-aim the motion sensor.
2. Decrease the sensitivity setting.
3. Do not use a dimmer or timer to control the light fixture. Replace the dimmer or timer with a standard on/off wall.

---The light flashes on and off:

1. Reposition the bulb away from the motion sensor.
2. Reposition the motion sensor.
3. The motion sensor is in "TEST" mode and warm up.

**The following parts are available for re-order if damaged or missing. Call our toll free at 1-800-887-6326.**

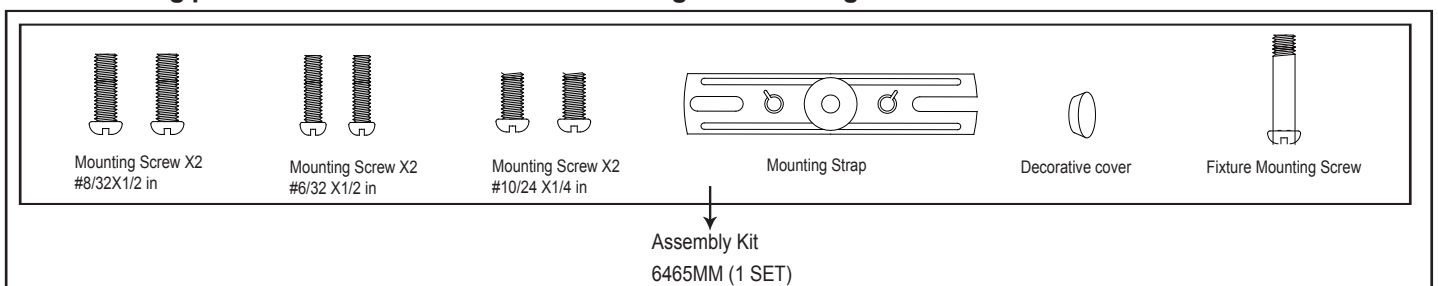

## 5-YEAR LIMITED WARRANTY:

All products are warranted to be free of defects in material and workmanship for five (5) years from date of purchase. This warranty is limited to the correction of any such defect, or the replacement of any such defective item(s), provided that: (a) we are properly notified and consent to return of the item(s) in question;(b) the item(s) is / are returned with proof of purchase date; and (c) it is found upon inspection by us that the item(s) is / are defective as noted above. This warranty does not cover labor costs, consequential damages, nor does it apply to any item(s) that have been improperly installed, overloaded, altered, or otherwise abused by the customer, its agent(s) or employee(s). Finishes are specially excluded from the terms of this warranty since they are subject to environmental maintenance deemed beyond our control. Other than the described obligation, we assume no further liability with respect to the sale or use of our products. We make no warranty, express or implied, and disclaim any warranty of merchantability or fitness for a particular purpose.

## FCC Statement

This device complies with Part 15 of the FCC Rules. Operation is subject to the following two conditions:

(1) this device may not cause harmful interference, and (2) this device must accept any interference received, including interference that may cause undesired operation.

Changes or modifications to this unit not expressly approved by the party responsible for compliance could void the user's authority to operate the equipment.

NOTE: This equipment has been tested and found to comply with the limits for a Class B digital device, pursuant to Part 15 of the FCC Rules. These limits are designed to provide reasonable protection against harmful interference in a residential installation. This equipment generates uses and can radiate radio frequency energy and, if not installed and used in accordance with the instructions, may cause harmful interference to radio communications.

However, there is no guarantee that interference will not occur in a particular installation. If this equipment does cause harmful interference to radio or television reception, which can be determined by turning the equipment off and on, the user is encouraged to try to correct the interference by one or more of the following measures:

- Reorient or relocate the receiving antenna.
- Increase the separation between the equipment and receiver.
- Connect the equipment into an outlet on a circuit different from that to which the receiver is connected.
- Consult the dealer or an experienced radio/TV technician for help.

